

*Thermo-Pipe Equipamentos industriais Ltda.*

# *Trocadores de calor*

## *Casco e tubos*

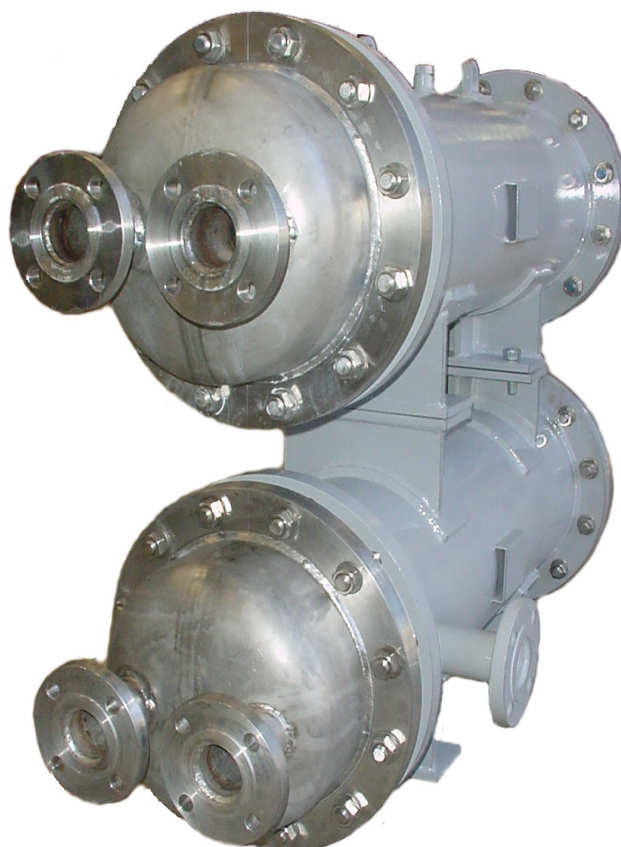

*R. Itaparantim, 10 – Jd. Presidente Dutra – CEP 07171-050 Guarulhos – SP*

*Tel./Fax (11) 2279-8667 – 2279-8967*

[www.thermopipe.com.br](http://www.thermopipe.com.br)

[thermopipe@thermopipe.com.br](mailto:thermopipe@thermopipe.com.br)



1

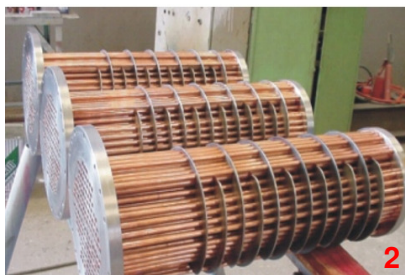

2

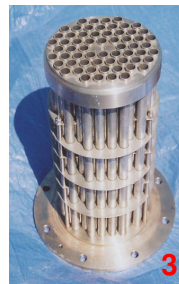

3

**Resfriador de óleo**

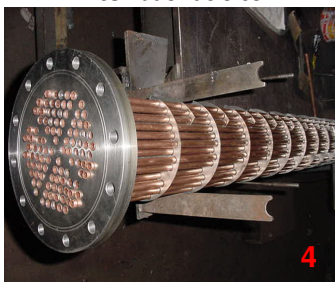

4

**feixe em "U" para trocador com dilatação**

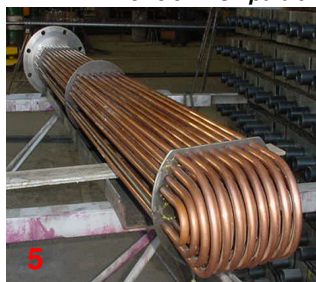

5



6

**feixe para compressor**

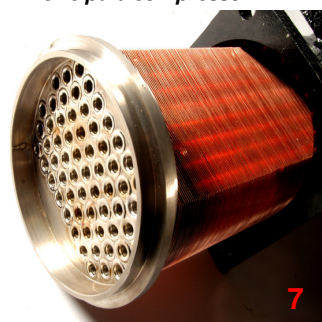

7

**Aquecedor a vapor**



8

**resfriador de óleo**



9

**Resfriador de óleo para usina hidroelétrica**

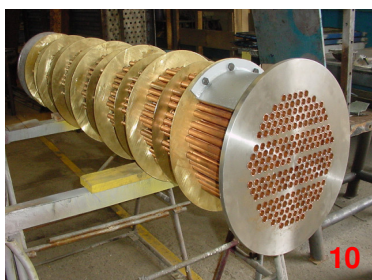

10



11



12



13

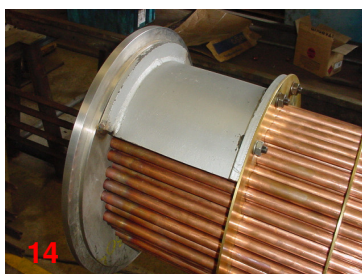

14

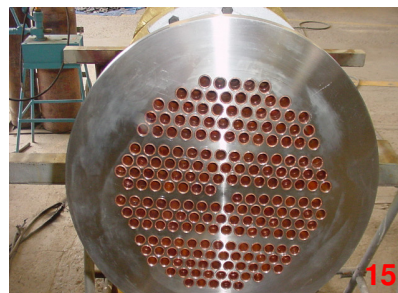

15



### Resfriador de óleo do mancal de escora de usina hidrelétrica



### Resfriadores de óleo hidráulico

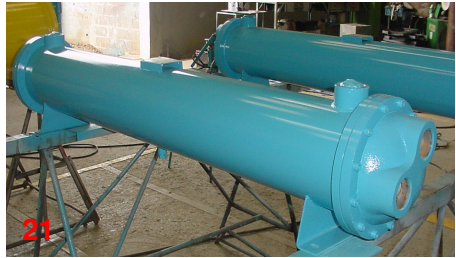

### Trocadores em inox

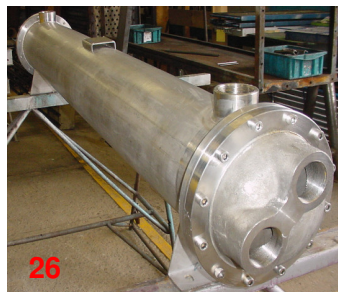
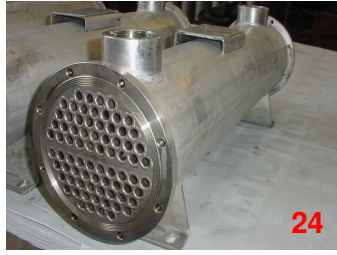

### Resfriador de óleo para tratamento térmico



### Refrigeradores para compressor

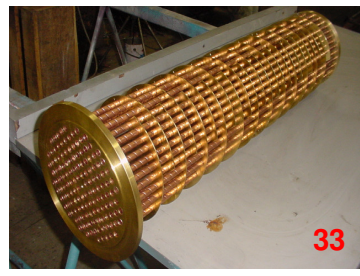
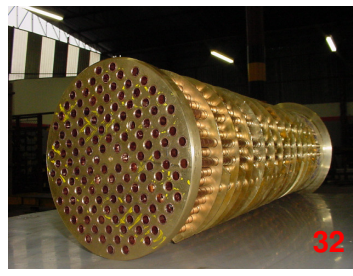
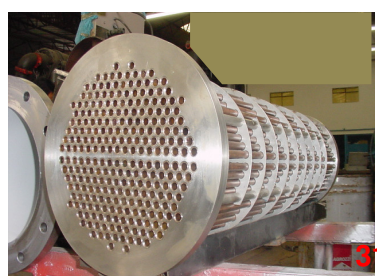



### Resfriador de água mediante água saigada ( plataforma de petroleo )

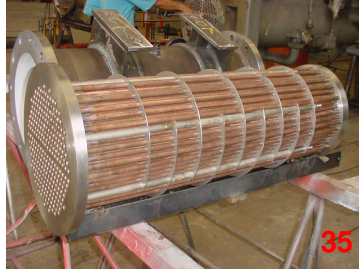
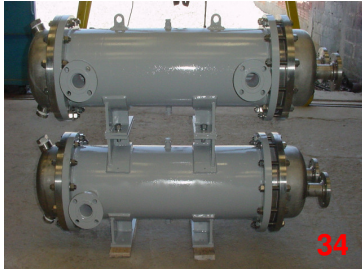

### feixe para compressor



### Resfriador de óleo ( furnas centrais elétricas )

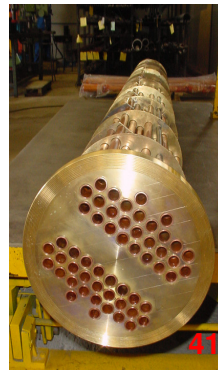
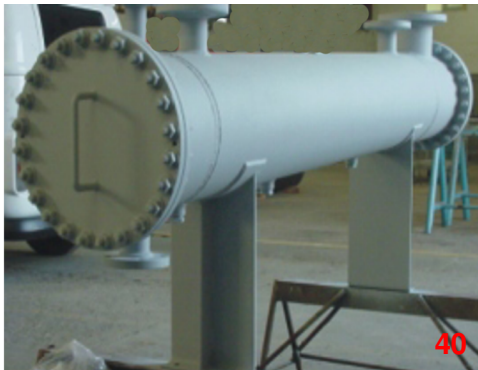
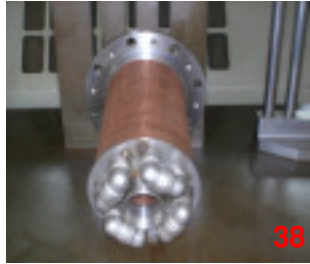

### Resfriadores para compressores de ar

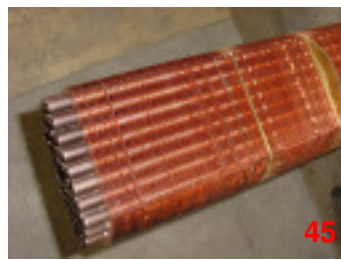
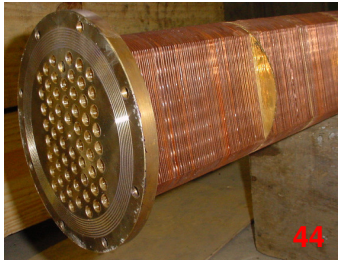

Os trocadores de calor padronizado são fabricados em aço carbono com tubos em cobre, podendo ser fabricados em outros materiais mediante consulta, os modelos abaixo são do tipo BEM, todos os equipamentos são testados hidrostaticamente a uma pressão de 8,0 Kgf/cm<sup>2</sup>.

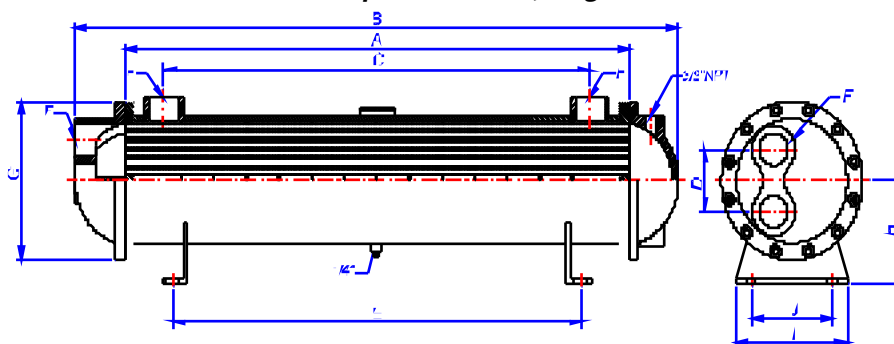

### TROCADOR PADRÃO 4" COM 2 PASSES

MODELO	A	B	C	D	E	F (NPT)	G	H	I	J	Ø do Corpo	Área de Troca
TP4-2- 300	300	393	200	50	150	3/4"	150	90	114	87	114	0,465
TP4-2- 400	400	493	300	50	250	3/4"	150	90	114	87	114	0,62
TP4-2- 500	500	593	400	50	350	3/4"	150	90	114	87	114	0,775
TP4-2- 600	600	693	500	50	450	3/4"	150	90	114	87	114	0,93
TP4-2- 700	700	793	600	50	550	3/4"	150	90	114	87	114	1,085
TP4-2- 800	800	893	700	50	650	3/4"	150	90	114	87	114	1,24
TP4-2- 900	900	993	800	50	750	3/4"	150	90	114	87	114	1,395
TP4-2- 1000	1000	1093	900	50	850	3/4"	150	90	114	87	114	1,55

### TROCADOR PADRÃO 4" COM 4 PASSES

MODELO	A	B	C	D	E	F (NPT)	G	H	I	J	Ø do Corpo	Área de Troca
TP4-4- 300	300	393	200	50	150	3/4"	150	90	114	87	114	0,357
TP4-4- 400	400	493	300	50	250	3/4"	150	90	114	87	114	0,476
TP4-4- 500	500	593	400	50	350	3/4"	150	90	114	87	114	0,595
TP4-4- 600	600	693	500	50	450	3/4"	150	90	114	87	114	0,714
TP4-4- 700	700	793	600	50	550	3/4"	150	90	114	87	114	0,833
TP4-4- 800	800	893	700	50	650	3/4"	150	90	114	87	114	0,952
TP4-4- 900	900	993	800	50	750	3/4"	150	90	114	87	114	1,071
TP4-4- 1000	1000	1093	900	50	850	3/4"	150	90	114	87	114	1,19

### TROCADOR PADRÃO 5" COM 2 PASSES

MODELO	A	B	C	D	E	F (NPT)	G	H	I	J	Ø do Corpo	Área de Troca
TP5-2- 500	400	529	270	60	250	1,1/2"	Ø 170	100	140	110	140	0,92
TP5-2- 750	750	879	620	60	600	1,1/2"	Ø 170	100	140	110	140	1,725
TP5-2- 1000	1000	1129	870	60	850	1,1/2"	Ø 170	100	140	110	140	2,3
TP5-2- 1250	1250	1379	1120	60	1100	1,1/2"	Ø 170	100	140	110	140	2,875
TP5-2- 1500	1500	1629	1370	60	1350	1,1/2"	Ø 170	100	140	110	140	3,45
TP5-2- 1750	1750	1879	1620	60	1600	1,1/2"	Ø 170	100	140	110	140	4,025
TP5-2- 2000	2000	2129	1870	60	1850	1,1/2"	Ø 170	100	140	110	140	4,6

### TROCADOR PADRÃO 5" COM 2 PASSES ALETADO

MODELO	A	B	C	D	E	F (NPT)	G	H	I	J	Ø do Corpo	Área de Troca
TP5-2- 500A	500	629	370	60	350	1,1/2"	Ø 170	100	140	110	140	3,57
TP5-2- 750A	750	879	620	60	600	1,1/2"	Ø 170	100	140	110	140	5,355
TP5-2-1000A	1000	1129	870	60	850	1,1/2"	Ø 170	100	140	110	140	7,14
TP5-2-1250A	1250	1379	1120	60	1100	1,1/2"	Ø 170	100	140	110	140	8,925
TP5-2-1500A	1500	1629	1370	60	1350	1,1/2"	Ø 170	100	140	110	140	10,71
TP5-2-1750A	1750	1879	1620	60	1600	1,1/2"	Ø 170	100	140	110	140	12,495
TP5-2-2000A	2000	2129	1870	60	1850	1,1/2"	Ø 170	100	140	110	140	14,28

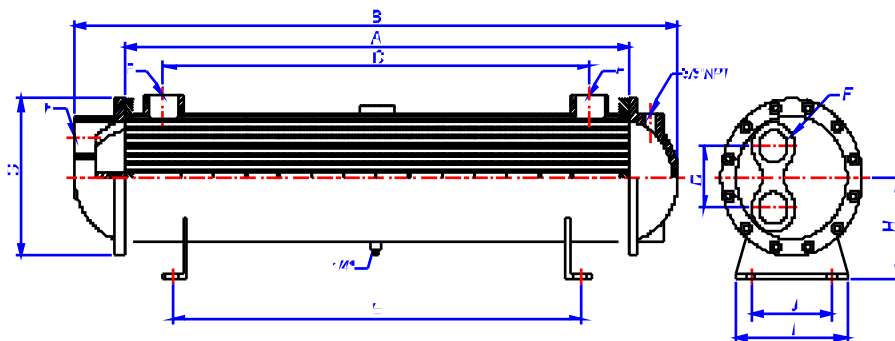

### TROCADOR PADRÃO 6" COM 2 PASSES

MODELO	A	B	C	D	E	F (NPT)	G	H	I	J	Ø do Corpo	Área de Troca
TP6-2- 500	500	641	360	72	350	1,1/2"	Ø 210	131	165	127	165	1,88
TP6-2- 750	750	891	610	72	600	1,1/2"	Ø 210	131	165	127	165	2,82
TP6-2- 1000	1000	1141	860	72	850	1,1/2"	Ø 210	131	165	127	165	3,76
TP6-2- 1250	1250	1391	1110	72	1100	1,1/2"	Ø 210	131	165	127	165	4,7
TP6-2- 1500	1500	1641	1360	72	1350	1,1/2"	Ø 210	131	165	127	165	5,64
TP6-2- 1750	1750	1891	1610	72	1600	1,1/2"	Ø 210	131	165	127	165	6,58
TP6-2- 2000	2000	2141	1860	72	1850	1,1/2"	Ø 210	131	165	127	165	7,52

### TROCADOR PADRÃO 6" COM 4 PASSES

MODELO	A	B	C	D	E	F (NPT)	G	H	I	J	Ø do Corpo	Área de Troca
TP6-4- 500	500	641	360	72	350	1,1/2"	Ø 210	131	165	127	165	1,67
TP6-4- 750	750	891	610	72	600	1,1/2"	Ø 210	131	165	127	165	2,505
TP6-4- 1000	1000	1141	860	72	850	1,1/2"	Ø 210	131	165	127	165	3,34
TP6-4- 1250	1250	1391	1110	72	1100	1,1/2"	Ø 210	131	165	127	165	4,175
TP6-4- 1500	1500	1641	1360	72	1350	1,1/2"	Ø 210	131	165	127	165	5,01
TP6-4- 1750	1750	1891	1610	72	1600	1,1/2"	Ø 210	131	165	127	165	5,845
TP6-4- 2000	2000	2141	1860	72	1850	1,1/2"	Ø 210	131	165	127	165	6,68

### TROCADOR PADRÃO 8" COM 2 E 4 PASSES

MODELO	A	B	C	D	E	F (NPT)	G	H	I	J	Ø do Corpo	Área de Troca
TP8- 500	500	698	345	110	310	2"	Ø 290	175	220	160	219	2,69
TP8- 750	750	948	595	110	560	2"	Ø 290	175	220	160	219	4,04
TP8- 1000	1000	1198	845	110	810	2"	Ø 290	175	220	160	219	5,38
TP8- 1250	1250	1448	1095	110	1060	2"	Ø 290	175	220	160	219	6,73
TP8- 1500	1500	1698	1345	110	1310	2"	Ø 290	175	220	160	219	8,07
TP8- 1750	1750	1948	1595	110	1560	2"	Ø 290	175	220	160	219	9,42
TP8- 2000	2000	2198	1845	110	1810	2"	Ø 290	175	220	160	219	10,76

### TROCADOR PADRÃO 10" COM 2 PASSES

MODELO	A	B	C	D	E	F (NPT)	G	H	I	J	Ø do Corpo	Área de Troca
TP10-2-500	500	641	360	130	350	3"	Ø 340	210	273	213	273	5,62
TP10-2-750	750	891	610	130	600	3"	Ø 340	210	273	213	273	8,43
TP10-2-1000	1000	1141	860	130	850	3"	Ø 340	210	273	213	273	11,24
TP10-2-1250	1250	1391	1110	130	1100	3"	Ø 340	210	273	213	273	14,05
TP10-2-1500	1500	1641	1360	130	1350	3"	Ø 340	210	273	213	273	16,86
TP10-2-1750	1750	1891	1610	130	1600	3"	Ø 340	210	273	213	273	19,67
TP10-2-2000	2000	2141	1860	130	1850	3"	Ø 340	210	273	213	273	22,48

### TROCADOR PADRÃO 10" COM 4 PASSES

MODELO	A	B	C	D	E	F (NPT)	G	H	I	J	Ø do Corpo	Área de Troca
TP10-4- 500	500	641	360	130	350	3"	Ø 340	210	273	213	273	5,32
TP10-4- 750	750	891	610	130	600	3"	Ø 340	210	273	213	273	7,98
TP10-4- 1000	1000	1141	860	130	850	3"	Ø 340	210	273	213	273	10,64
TP10-4- 1250	1250	1391	1110	130	1100	3"	Ø 340	210	273	213	273	13,3
TP10-4- 1500	1500	1641	1360	130	1350	3"	Ø 340	210	273	213	273	15,96
TP10-4- 1750	1750	1891	1610	130	1600	3"	Ø 340	210	273	213	273	18,62
TP10-4- 2000	2000	2141	1860	130	1850	3"	Ø 340	210	273	213	273	21,26

Os comprimentos dos trocadores podem ser alterados de acordo com a necessidade de cada cliente.